

INSTRUCTION MANUAL

CONTENTS

- SAFETY PRECAUTIONS 2~4
- HOW TO USE 5~6
- CLEANING 6
- IN CASE OF THE FOLLOWING..... 7
- BEFORE REQUESTING SERVICE..... 8
- LED CONTROLLER..... 11

Please read these instructions completely
before operating the units.

SAFETY PRECAUTIONS

- To ensure proper use, please thoroughly study these SAFETY PRECAUTIONS before operating the Unit.
- The purpose of the safety precautions in this manual is to ensure safe and correct use of the unit to minimize risks that could cause serious damage and injury to you or other persons. The safety precautions are divided into WARNINGS and CAUTIONS. Cases where improper handling of the unit could lead to death or serious injury are listed under the "⚠️WARNING" heading. However, the cases listed under the "⚠️CAUTION" heading could also lead to serious results. To ensure the safety, adhere strictly to both types of safety precautions.

⚠️ WARNING Improper handling of the unit could lead to death or serious injury.

⚠️ CAUTION Improper handling of the unit could lead to serious results depending on the circumstances.

- ❗ contains information that should be strictly adhered to.
- After reading the instruction manual, store it in an easily accessible place where the user(s) of this product can easily find it.

◆ PRECAUTIONS FOR INSTALLATION

⚠️ WARNING



Installation should be performed only by the dealer or a qualified expert. Attempting to install the unit yourself could result in water leakage, refrigerant leakage, electrical shock, or fire.

◆ PRECAUTIONS FOR USE

⚠️ WARNING



DONT TAMPER

All repairs, disassembly and modifications should be performed only by qualified technicians. Attempting to perform these yourself could result in a fire, malfunction, and injury.

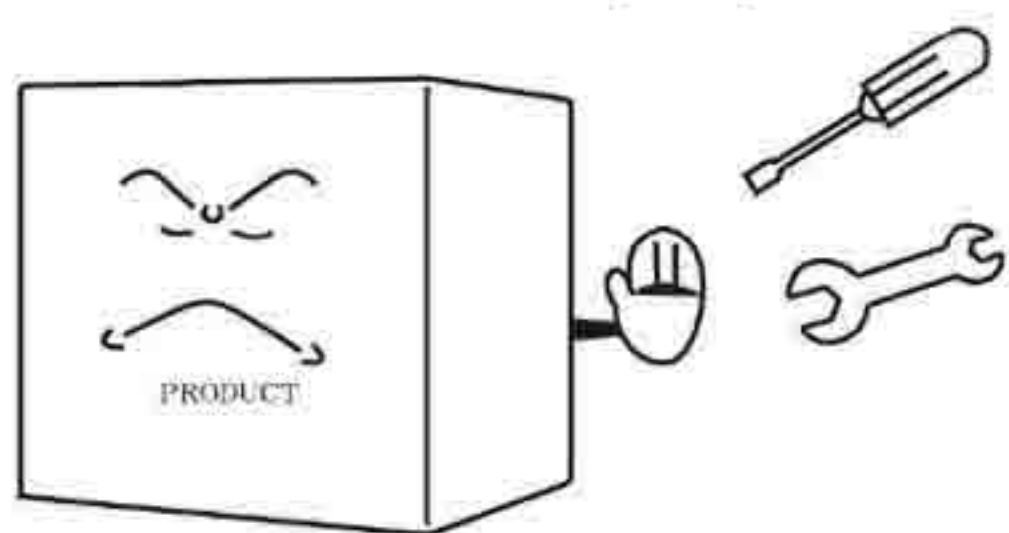

ELECTRICAL SHOCK HAZARDS

Never splash water directly onto the product or wash with water as short-circuit and electrical leakage could result.

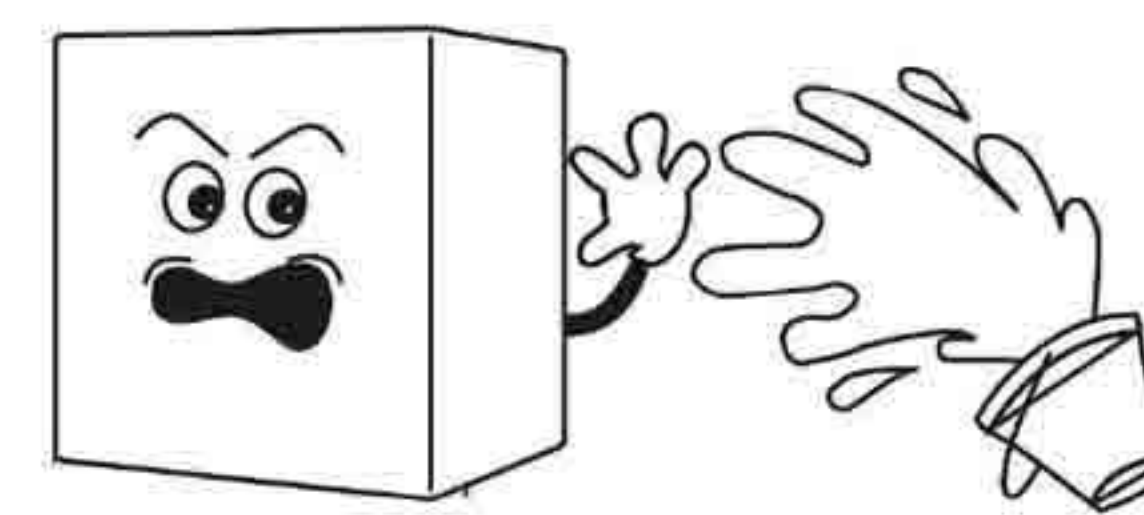

DANGER OF EXPLOSION

Never put flammable or volatile substances into the unit as explosions and fire could result.

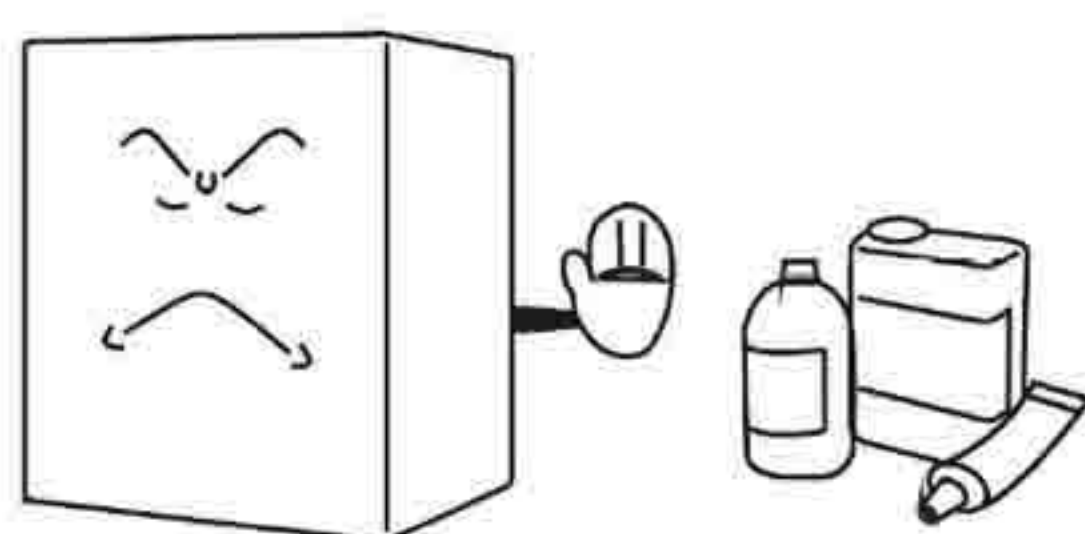

PROHIBITED

Do not damage, modify, excessively bend, strain, twist or bundle up the power cord. Also, placing heavy objects on the power cord or squeezing it in a tight place could damage it, possibly resulting in electrical shock or fire.

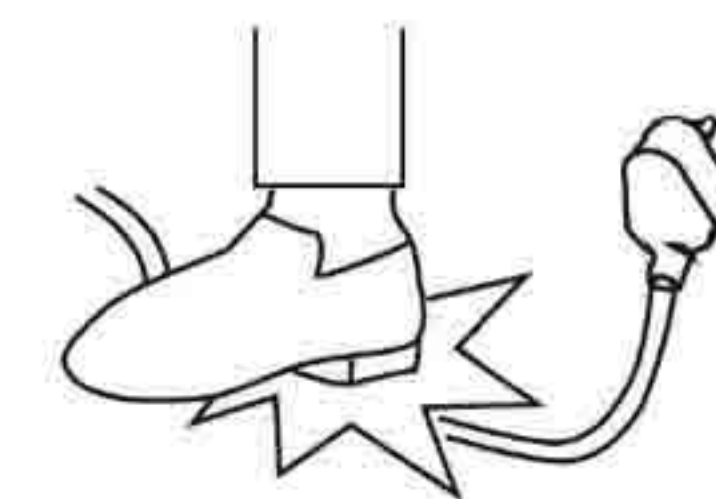

PROHIBITED

Use a dedicated wall outlet. Do not use extension cords or convenience receptacles as this could result in electrical shock, overheating and a fire.

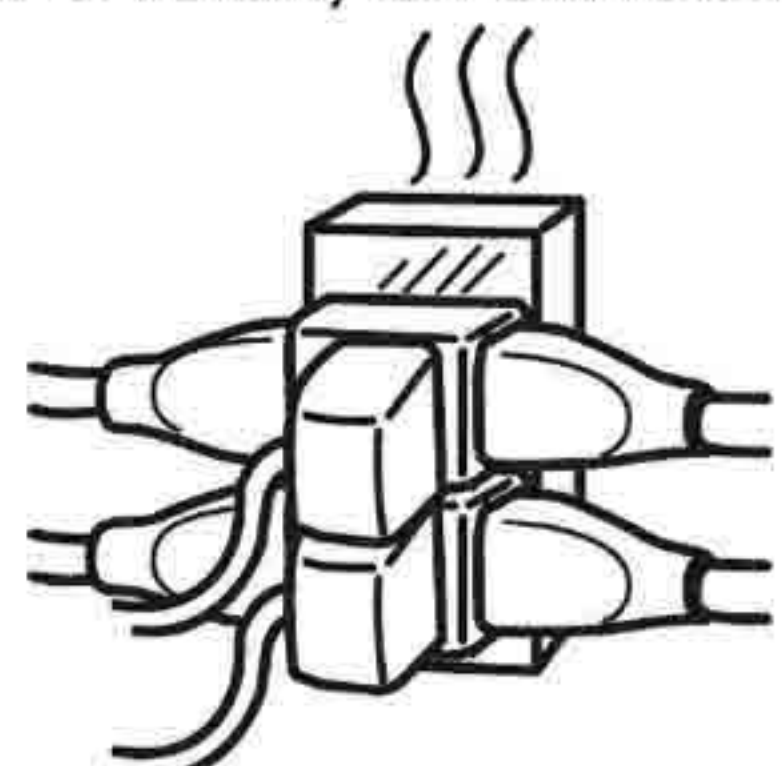

FLAMMABLE

Never use flammable spray cans or leave flammable substances near the unit. Sparks from electrical switches could result in explosion and fire.

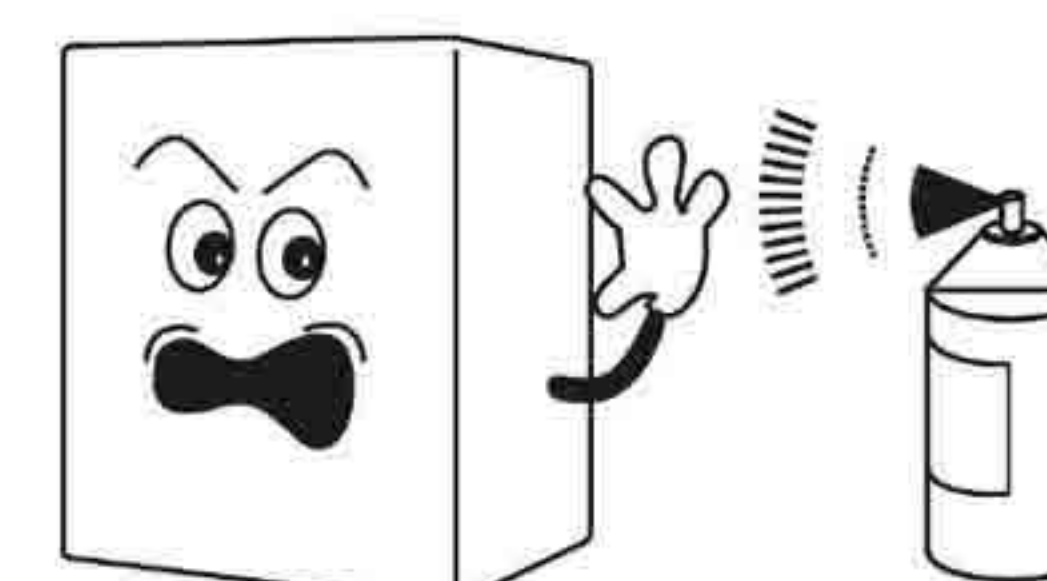



SAFETY PRECAUTIONS

⚠️ WARNING



The cooler is intended for storage and display of beverages for sale. Do not use for other purpose than intended as this could adversely affect items placed in the unit.

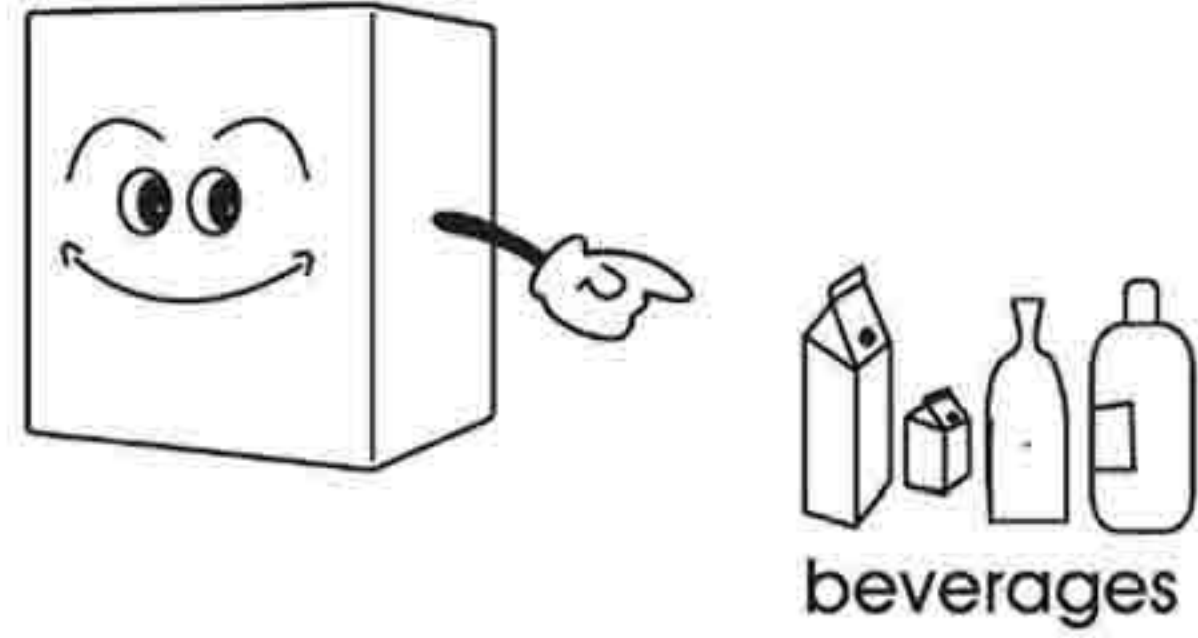

beverages



ROTATING DEVICE

Never attempt to insert fingers, sticks, etc. into the cold air suction outlet as a circulation fan is rotating at high speed inside the outlet. Injury, electrical shock and improper operation could result.

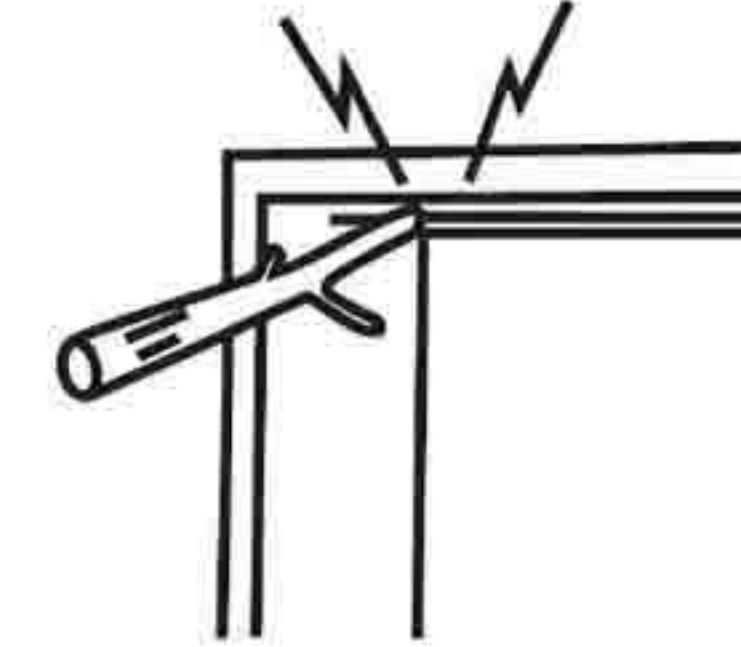

PROHIBITED

For indoor use only. Using the unit in a location exposed to rain could result in electrical leakage and electrical shock.

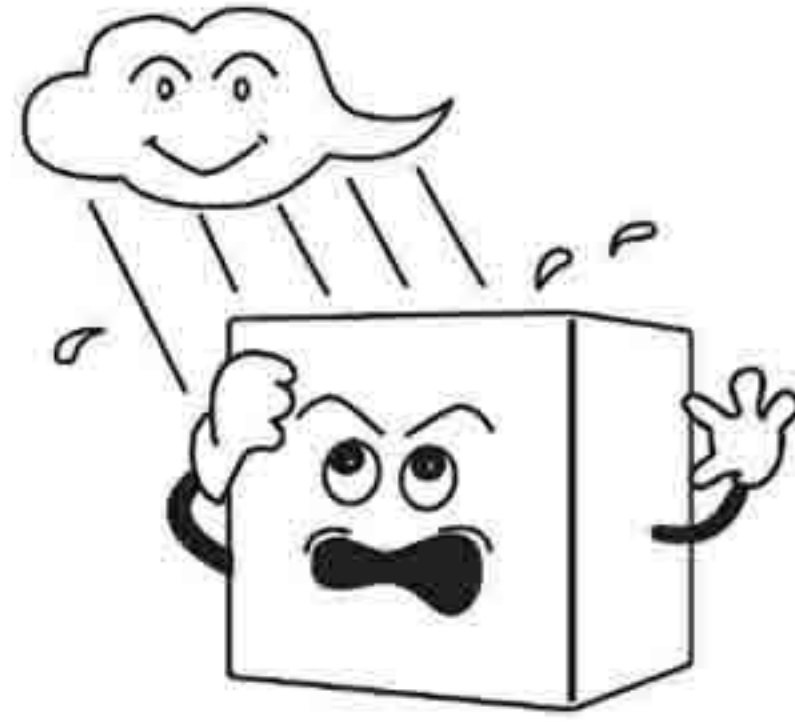

PROHIBITED

Never place heavy objects or items containing water on top of the unit. Objects could fall down and cause injury and spilled water could deteriorate the insulation of electrical components and result in electrical leakage.

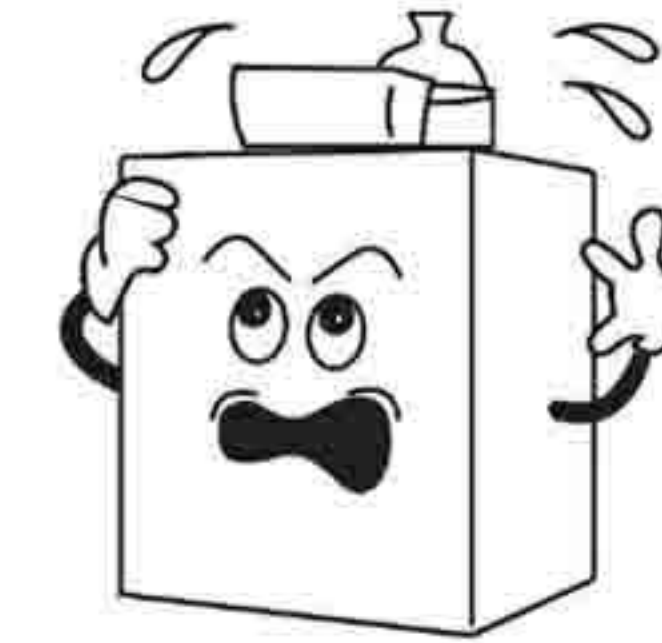

Install the unit in a location where the floor is sturdy enough to support the load of the unit. If the floor is not sturdy enough or installation is incorrectly performed, the unit could tip over and falling shelves and products could cause personal injury.

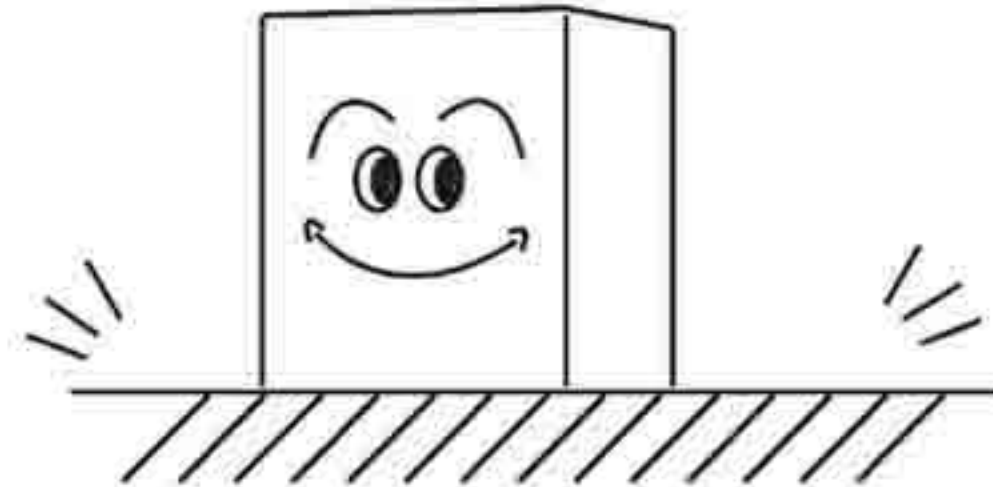

CAUTION AGAINST EXPLOSION

If you find gas leakage, please don't touch the chest freezer, and close gas and open the door for ventilation. Gas leakage could cause explosion, fire, and fire injury.

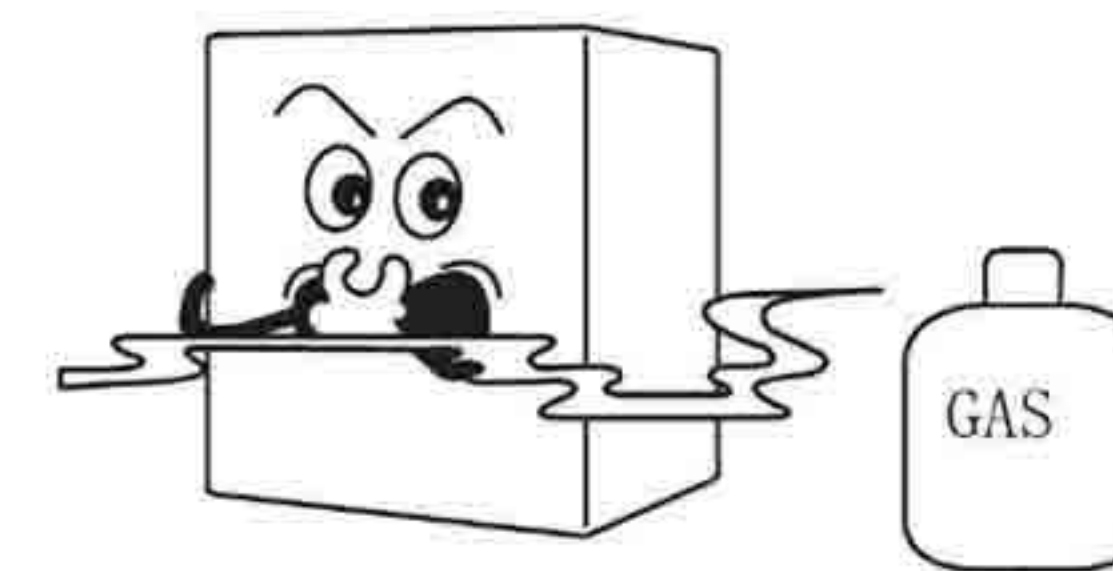

Store the unit in a location where it is not exposed to rain. Using a unit that has been exposed to rain could result in electrical leakage and electrical shock.

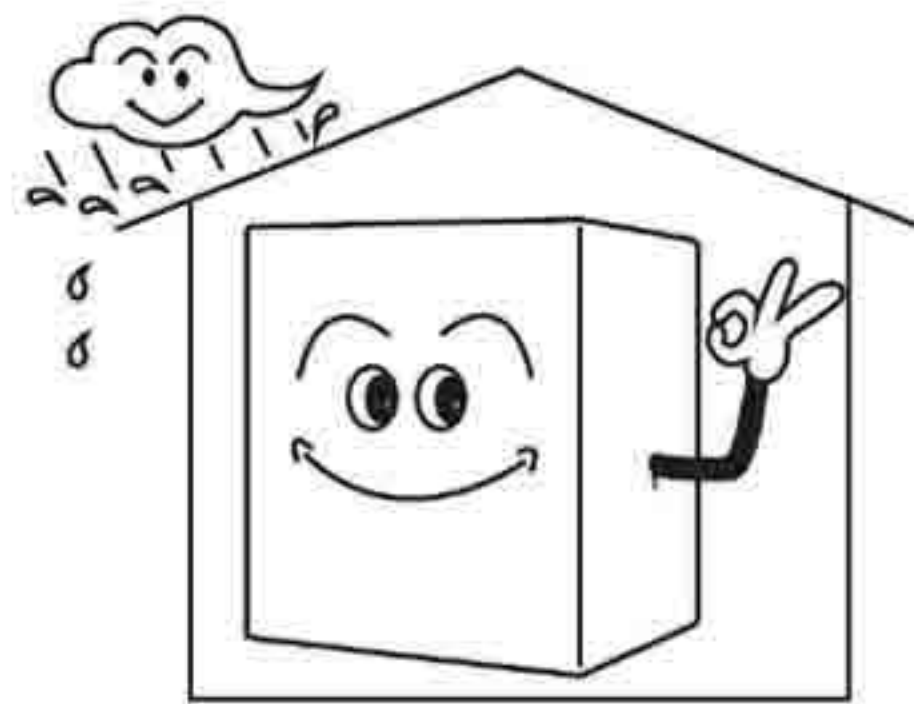

Keep away from hot air sources
Cooling performance is reduced if the unit is placed near heat sources such as hot plates and stoves and if it is exposed to direct sunlight.



Leave disassembly and disposal of the unit to qualified experts.

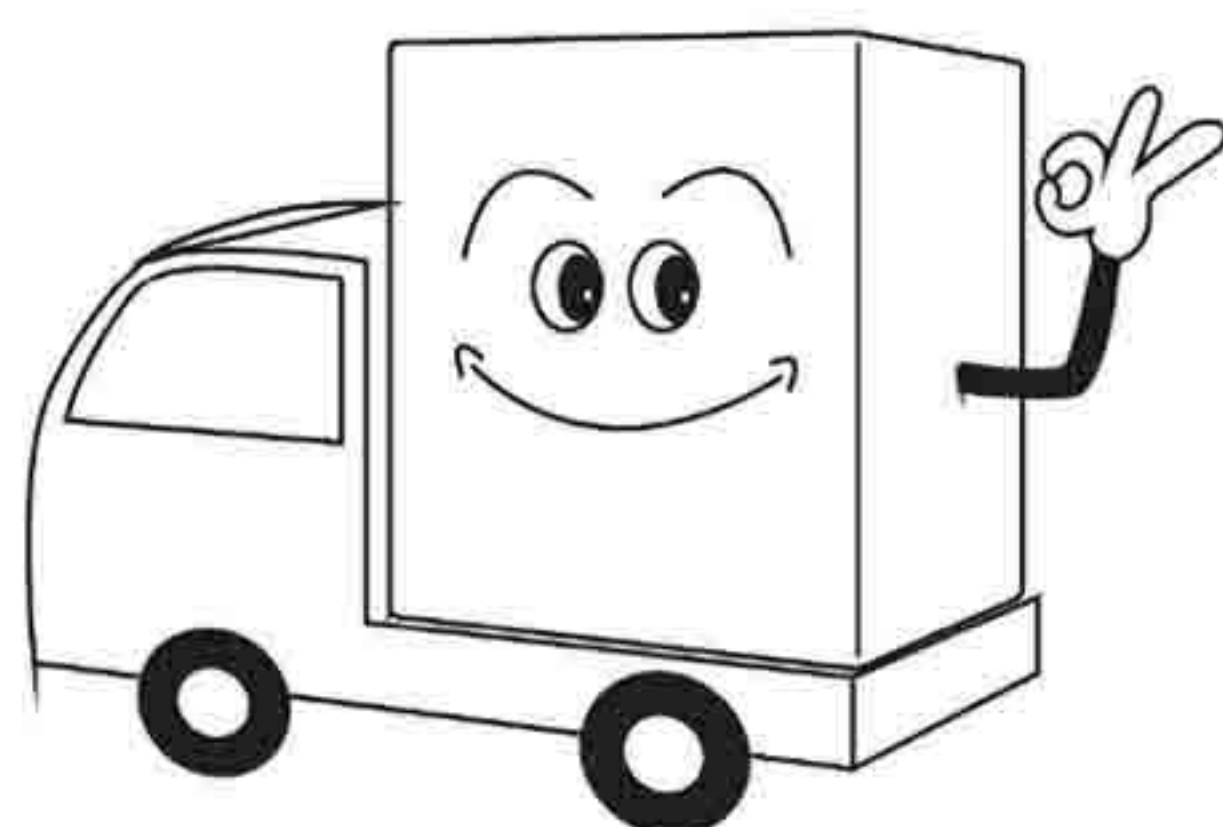

Should the unit need temporary storage, make sure not to store the unit in a location where children play and take precautions so that the door cannot be completely closed. This will minimize the risk that a child becomes trapped inside the compartment.



SAFETY PRECAUTIONS

⚠️ WARNING

WELL VENTILATED PLACE

Please make sure there is more than 10cm space between UPRIGHT COOLER and the wall. If there is no space, cooling capacity can drop.

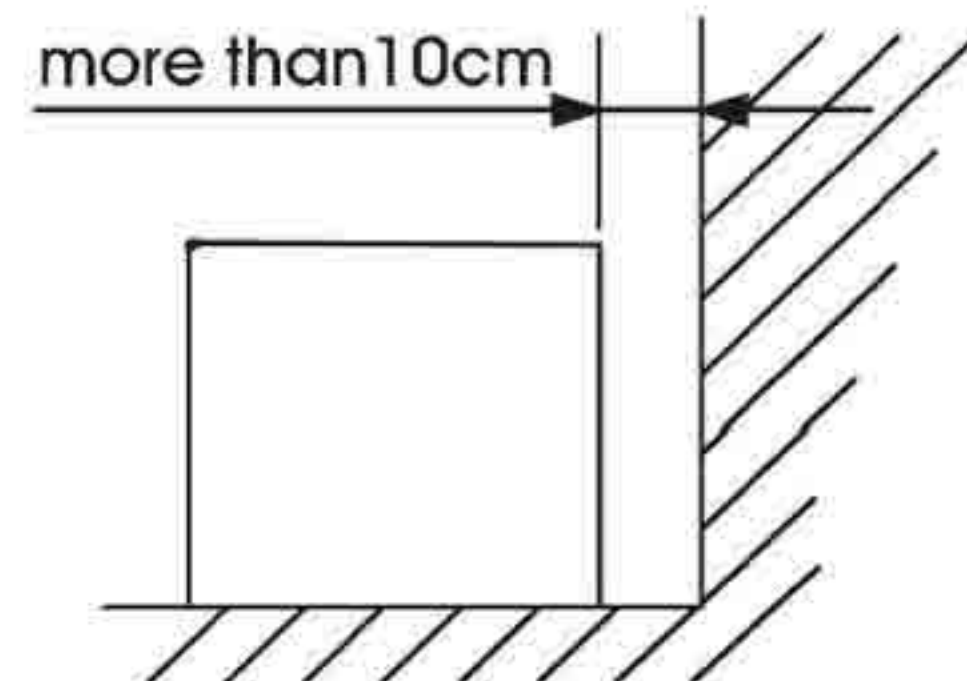

If installation in a damp location is unavoidable, install an electrical leakage circuit breaker. If no electrical leakage circuit breaker is installed, an electrical shock could result.

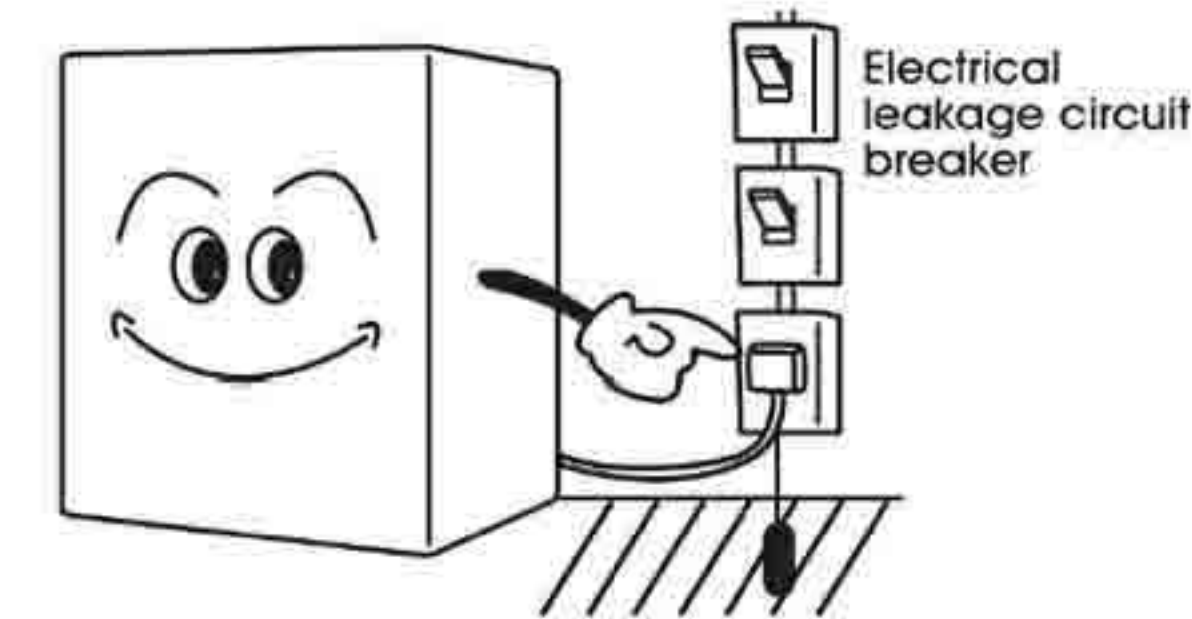

PROHIBITED

Never hang from the door or climb onto the unit. The unit could tip over or fall and cause material damage or injury.

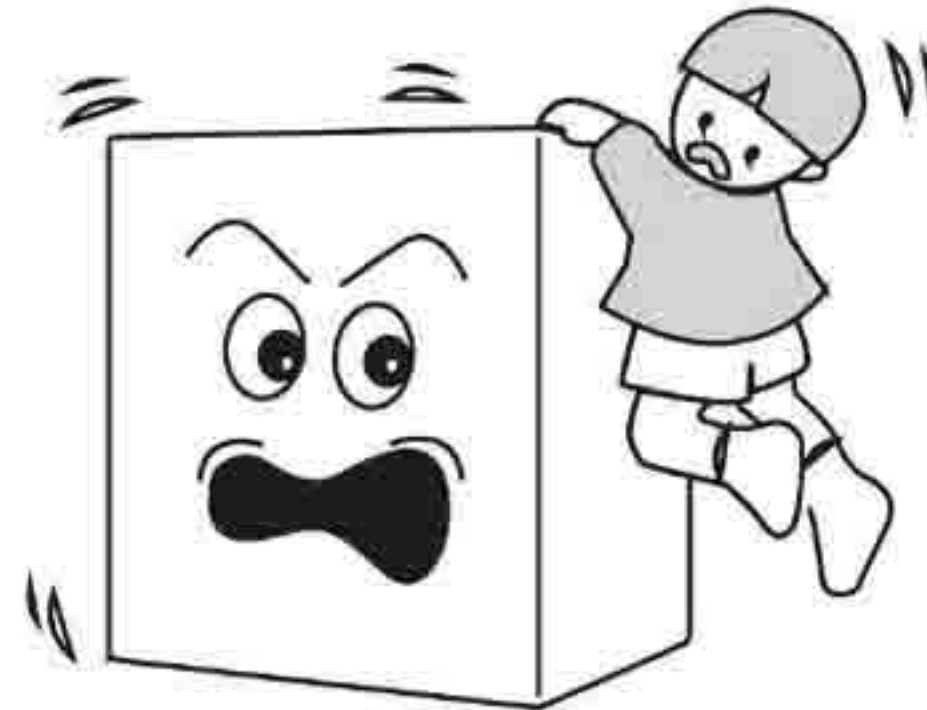

DISCONNECT POWER CORD PLUG FROM WALL OUTLET

Disconnect the power cord plug from the wall outlet before moving the unit and make sure that the power cord is not damaged during transport. A damaged power cord could result in electrical shock and/or fire.

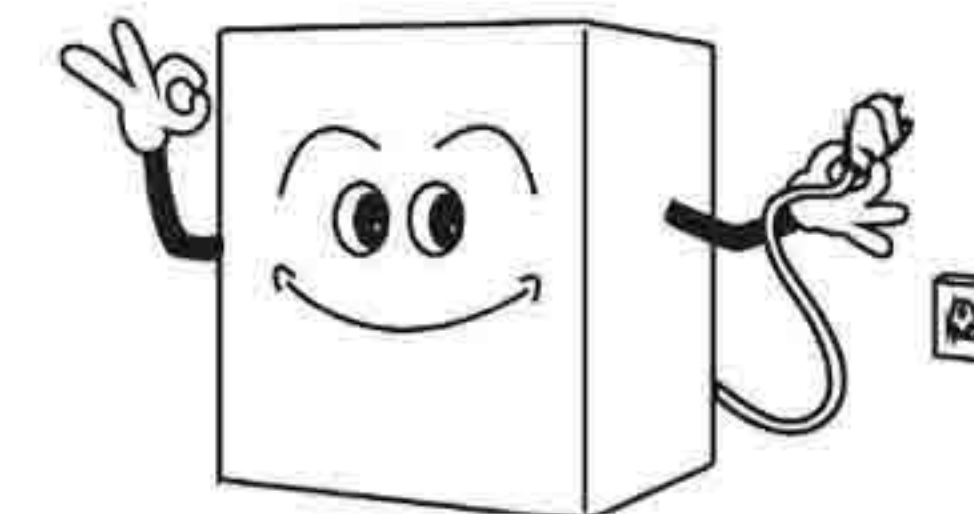

DON'T PINCH FINGERS

Grasp the handle when closing the door. Holding at other positions could result in pinched fingers and injury.

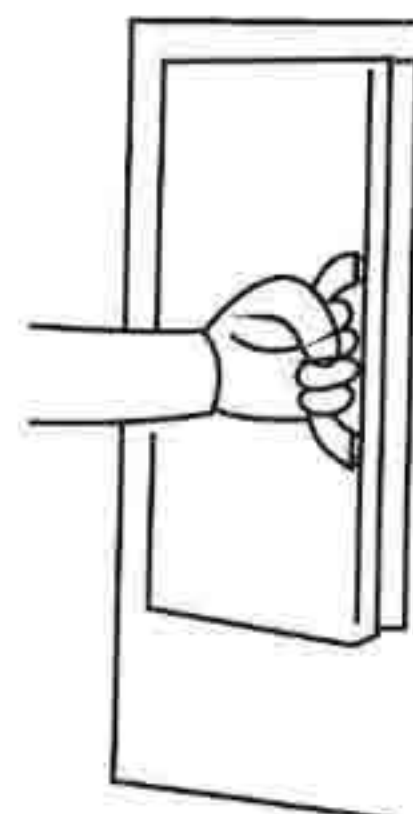

Do not touch

Do not push hand against or apply excessive force to glass surfaces as the glass could break and cause injury.



When disconnecting the power cord plug from the wall outlet, hold the plugs main body close to the outlet. Pulling the cord could cause wire breakage, possibly resulting in overheating and fire.

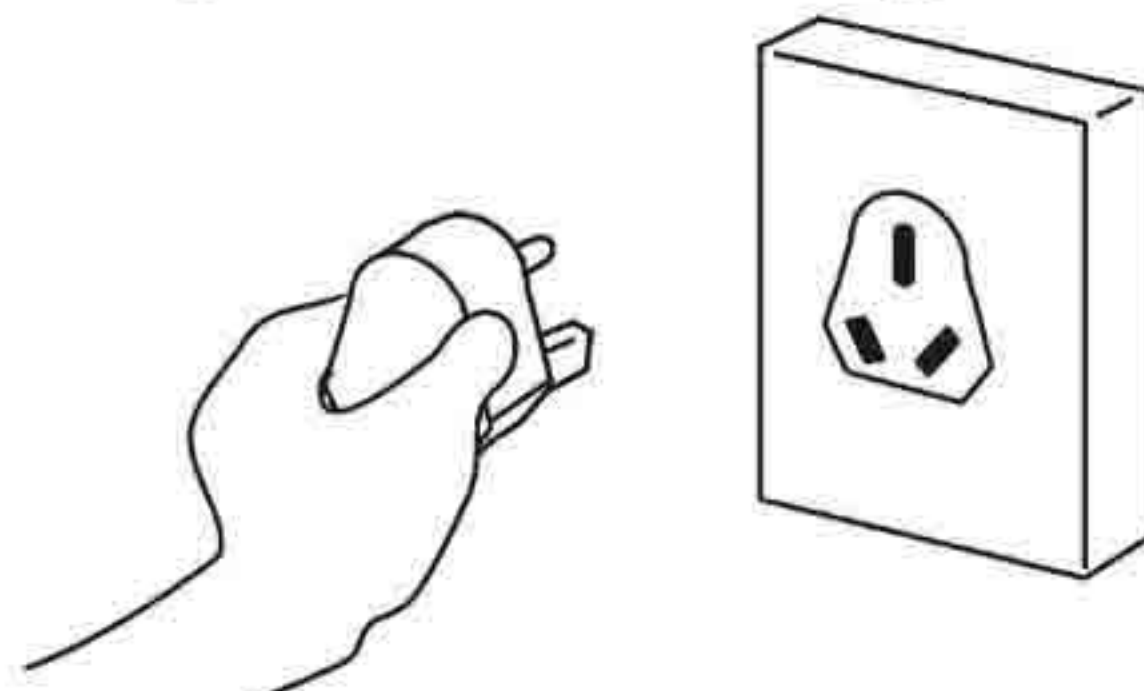

Make sure that the unit does not tip over or fall when it is moved. A falling unit could cause serious injury.

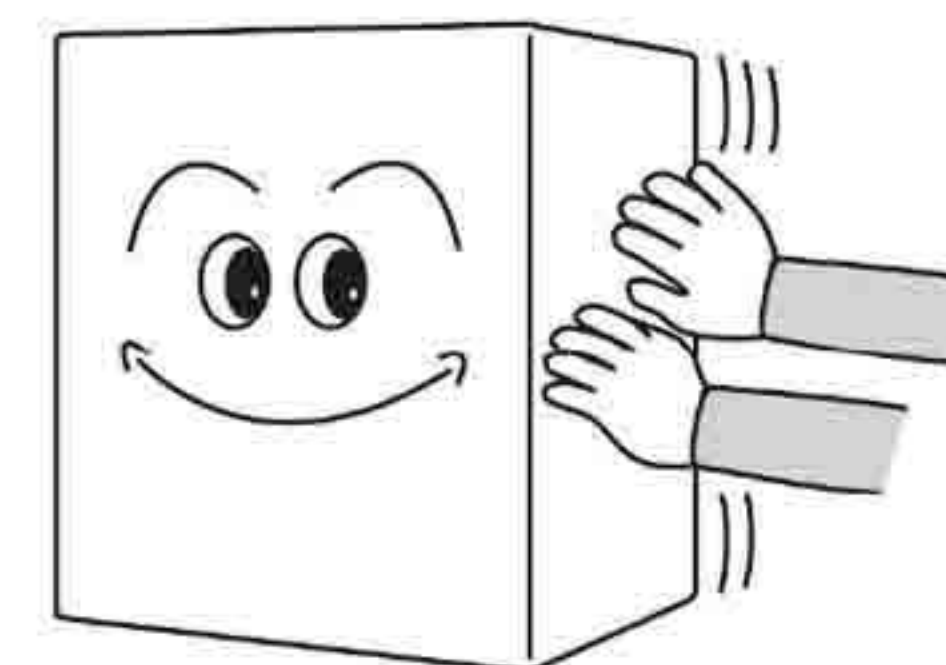

PROHIBITED

Do not throw items onto the shelves and do not place items totaling more than 65lbs on each shelf. The shelf could fall down, possibly causing injury.



Be sure to attach and secure shelves correctly. An improperly attached shelf could fall down and cause injury.

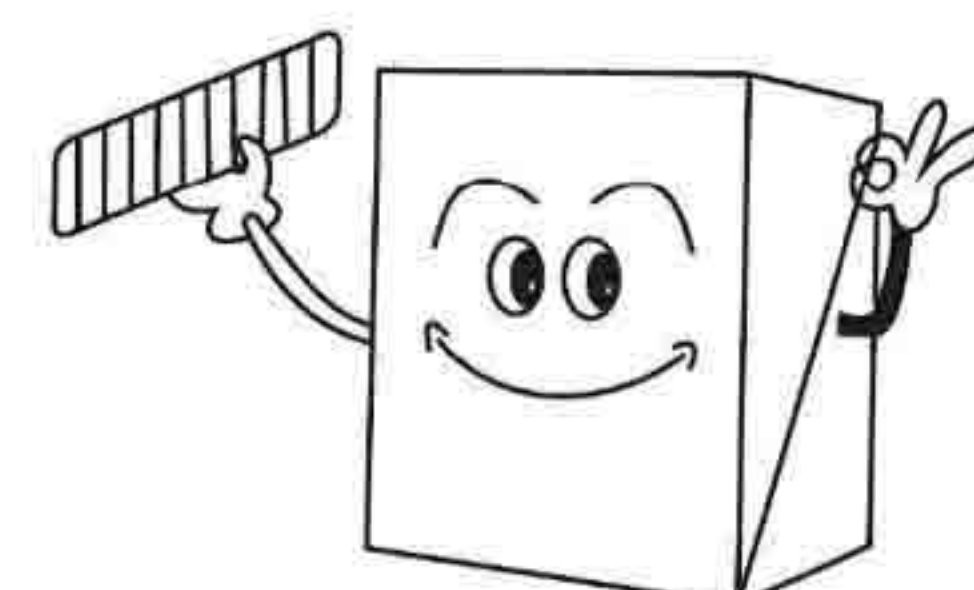



HOW TO USE

BEFORE USE

- Remove shipping package, tape, etc, and leave doors open ventilate for a while.
- The unit is cleaned before shipment. However, clean the compartment interior after delivery.
- Please insert power supply plug into the wall outlet ,single-phase cat voltage.
- Allow the unit to operate for about 1 hour to cool the compartment before placing items in the cooler.

WAIT 5 MINUTES OR MORE BEFORE RE-STARTING

- Restarting the unit immediately after it has been turned off may cause fuses to blow and activate the circuit-breaker, the compressor may be overloaded, and/or other damage may occur.

TEMPERATURE ADJUSTMENT

For showcase cooler, the interior temp. during fully loaded at factory default setting of position at 4-5 will be kept at 0-10°C., If the ambient temp. is extremely high or the stuffing food inside is too much, which might cause the interior temp. a little bit higher. So, it would be better turn the thermostat right so as to maintenance the right temp. On the opposite, if the ambient temp. is very low or empty loaded, or in less food storage, the interior temp. might be able to reach minus 0°C, and in return to cause the evaporator ice up; Thus, it would better switch the thermostat back to left so as to relieve something.

DRAIN TRAY

- Defrosting is performed automatically and drain water is collected in the drain tray.
- Water in the drain tray is evaporated automatically. In humidity, there is a large amount of water in the drain tray, so please throw away drain water once a day.

EFFICIENT USE

- To prevent cold air from escaping, open and close the door quickly and keep the door opened for as short a time as possible.
- Please install the unit in the place which is well-ventilated.

SHELF HEIGHT ADJUSTMENT

The shelf height can be adjusted.

Arrange the shelves in accordance with the dimensions of the items to be placed in the cooler.



HOW TO USE

PLACING ITEMS IN THE SHOWCASE

This showcase employs a forced circulation of cold air system. If circulation of cold air is obstructed, the items will not be adequately refrigerated. Pay attention to the following points:

- Do not let items obstruct the cold air inlet and suction outlet.
- Place items so that they do not protrude from the shelves. The gap between the shelves and the door is used for circulation of cold air.
- Place items evenly on all shelves.
- Please do not display goods on the bottom. Please put goods on the shelf.

INSTRUCTION MANUAL

CLEANING

**WARNING**

To prevent any electrical shock hazards or injury by rotating circulation fan, always disconnect the power cord plug from the wall outlet before cleaning.

1 EXTERIOR AND COOLER COMPARTMENT

Wipe with a soft, dry cloth. If very soiled, wipe with a cloth that has been moistened with a detergent. Then wipe with a cloth that has been dipped in water.

**WARNING**

WARNING: Do not splash water directly onto the cooler and do not wash with water. Short-circuit and electrical shock could result.

- Clean the cooler regularly to keep it clean at all times.
- Never use polishing powder, soap powder, benzine, oil or hot water as these will damage the painting and plastic components.

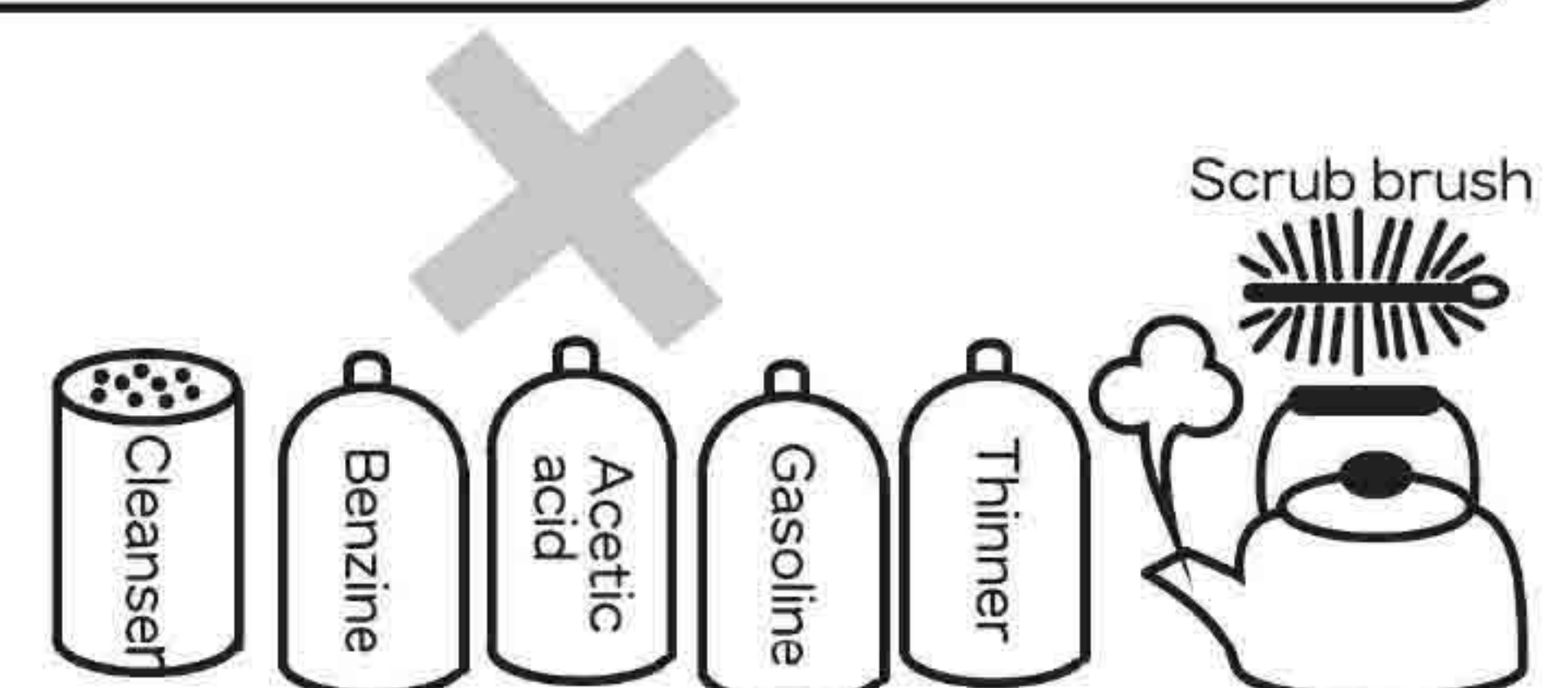

2 CHECKS

To ensure the safety, perform the following checks after cleaning.

- Is the power cord plug firmly inserted into a dedicated wall outlet? Confirm that the plug is not abnormally hot.
- Check the power cord for cracks and damage. Should the slightest irregularity be observed, contact the dealer from whom you purchased this unit or our customer's service.



IN CASE OF THE FOLLOWING

1 POWER FAILURE

Keep opening and closing of the door to a minimum.
Avoid placing new items in the cooler as this will raise the temperature inside the compartment.

2 WHEN NOT USED FOR A LONG PERIOD

Remove all items from the compartment and disconnect the power cord plug from the wall outlet.
Clean the compartment interior and wipe away all water.
To prevent mold formation and bad smell, leave the door open to dry the compartment completely.

3 TRANSPORTATION

Disconnect the power cord plug from the wall outlet.
When moving the cooler, make sure that the feet do not damage the power cord.
Do not let the feet hit against floor steps, thresholds, etc.

4 TEMPORARY STORAGE

Affix a piece of wood, etc. Between the door and main unit to prevent complete closing of the door.
Make sure not to store the unused cooler at a location where children play.
Should a child enter the compartment and the door is closed, the child may not be able to open the door from the inside.

INSTRUCTION MANUAL

BEFORE REQUESTING SERVICE

Please check the following items if you encounter problems with the unit. If the problem continues after taking the proper remedial actions, disconnect the power cord plug from the wall outlet. Transfer the items stored in the cooler to a box or other container. Then contact the dealer from whom you purchased this unit and be ready to provide information as listed in "REQUIRED INFORMATION" below.

**WARNING**

To prevent any electrical shock hazards, do not disconnect the power cord plug from the wall outlet with wet hands.



BEFORE REQUESTING SERVICE

<p>No refrigeration at all</p>	<ul style="list-style-type: none"> ● Is the power supply interrupted? ● Is the power cord plug disconnected from the wall outlet? ● Are the shop's power fuses blown and/or the circuit breaker activated?
<p>Inadequate refrigeration</p>	<ul style="list-style-type: none"> ● Is the temperature setting appropriate? ● Are items obstructing the cold air inlet and suction outlet? ● Are stored items packed too tight? ● Is the door open or is it opened and closed frequently? ● Is the condenser clogged?
<p>Excessive noise</p>	<ul style="list-style-type: none"> ● Are all feet in firm contact with the floor? ● Is the rear panel of the cooler contacting the wall or other objects? ● Are other objects in contact with the cooler?
<p>Condensation on cooler exterior</p>	<ul style="list-style-type: none"> ● Condensation may condense on the exterior and door during hot and humid days or depending on the place of installation. This occurs when the humidity is high and water particles in the air contact cold surfaces. This is normal. wipe away condensation with a dry cloth.

Showcase sometimes stops running when the thermostat turns off.

INSTRUCTION MANUAL

REQUIRED INFORMATION

- | | |
|--|---|
| <p>① Nature of malfunction
(as accurately as possible)</p> | <p>④ Customer's name, address,
phone number</p> |
| <p>② Product number</p> | <p>⑤ Year and date of purchase</p> |
| <p>③ Serial number</p> | <p>⑥ Desired date for service visit</p> |
- } ON RATING LABEL
ON CARTON

EZ1X TEMPERATURE CONTROLLER USER MANUAL



EZ11RXC EZ12RXC EZ12DRXC

1. DIMENSIONS AND CUT OUT

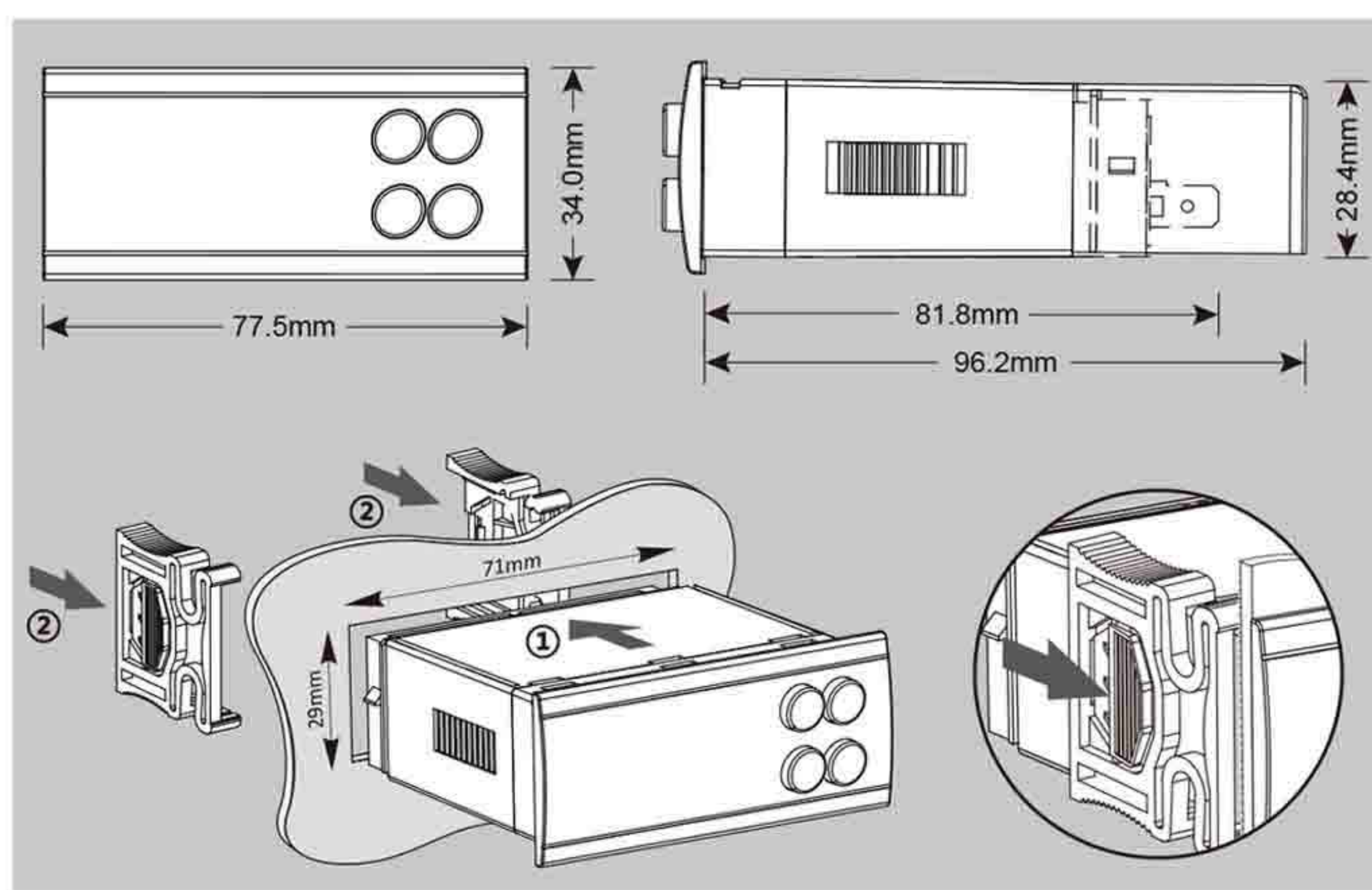

Installation Precautions

- Do not place the equipment near heat sources, strong magnetic equipment, or in places exposed to direct sunlight, rain, humidity, dust, or mechanical vibration.

2. CONNECTIONS

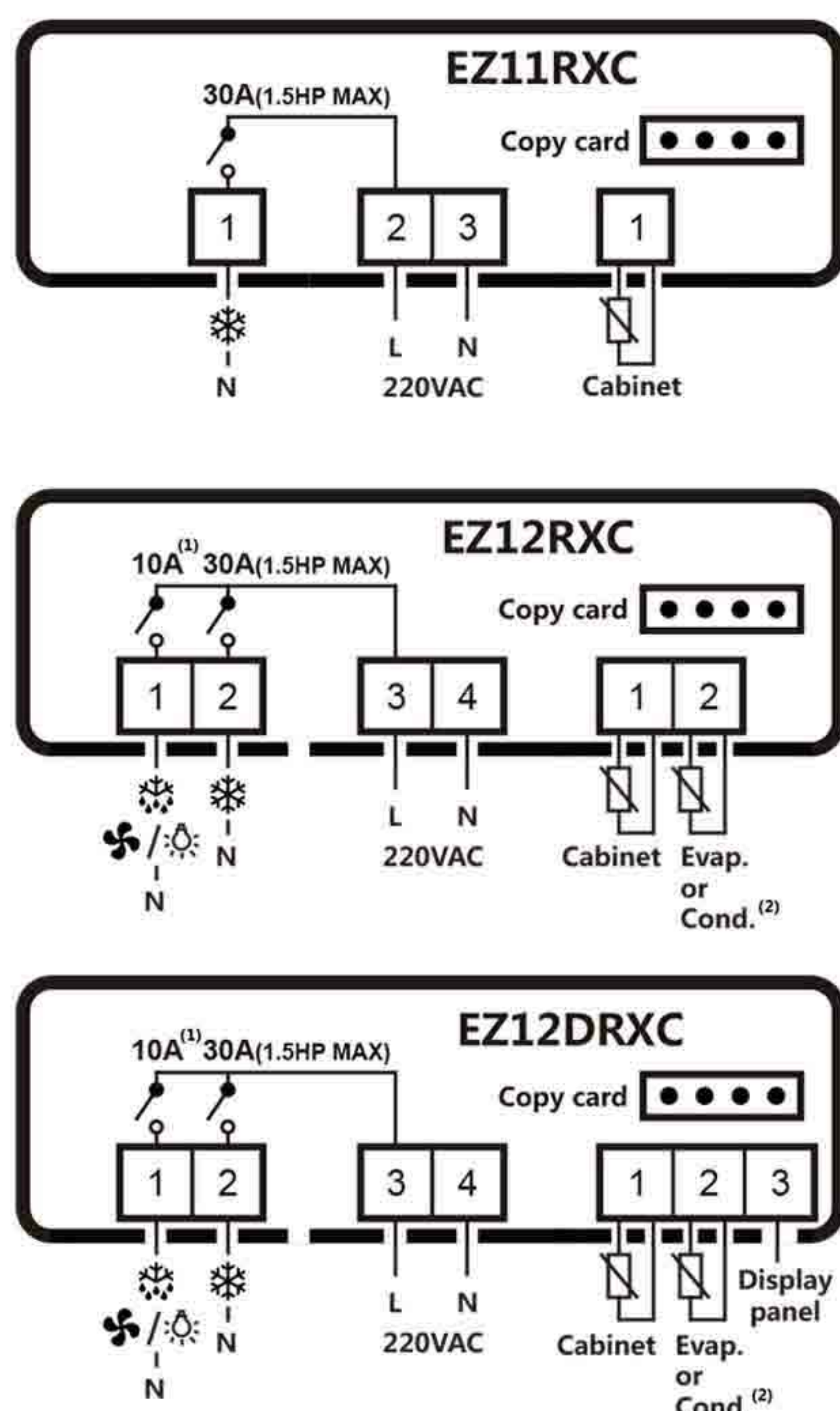

Note (1): The second relay;
Note (2): The second probe;

EZ1X User Manual | Code M03C200901 | SEP 01st, 2020 Ver1.00

3. FRONT PANEL AND COMMANDS

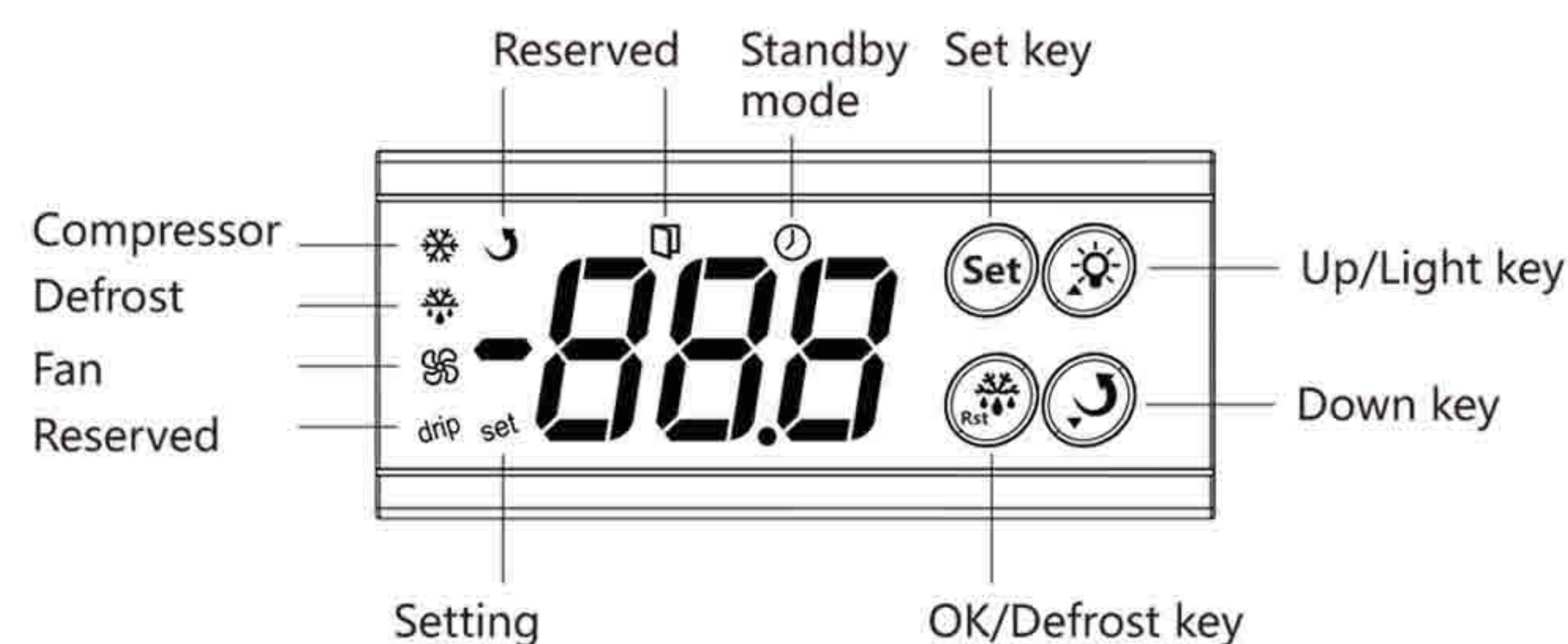

Set key | Set

- Press and release to enter the interface for changing the setpoint ;
- Press and hold for 3 seconds to enter the manger parameter interface ;
- Switch menu and parameter interface ;

OK/Defrost key |

- View the temperature of the second probe ;
- Save the parameters and exit ;
- Press and hold this key for 3 seconds to start/terminate defrosting ;

Up/Light key |

- Scrolled up the values or parameters ;
- Turn on or turn off the lights (only valid for EZ12 series and Pr=2) ;

Down key |

- Scrolled down the values or parameters ;

Combination key | Set +

- In power-on mode, press and hold the set key and the OK/defrost key for 3 seconds, the controller enters the standby mode;
- In standby mode, press and hold the set key and the OK /defrost key for 3 seconds, the controller restarts.



Danger : Before performing any type of maintenance, cut off the electrical connection, Do not maintain in standby mode to avoid electric shock!

Change setpoint

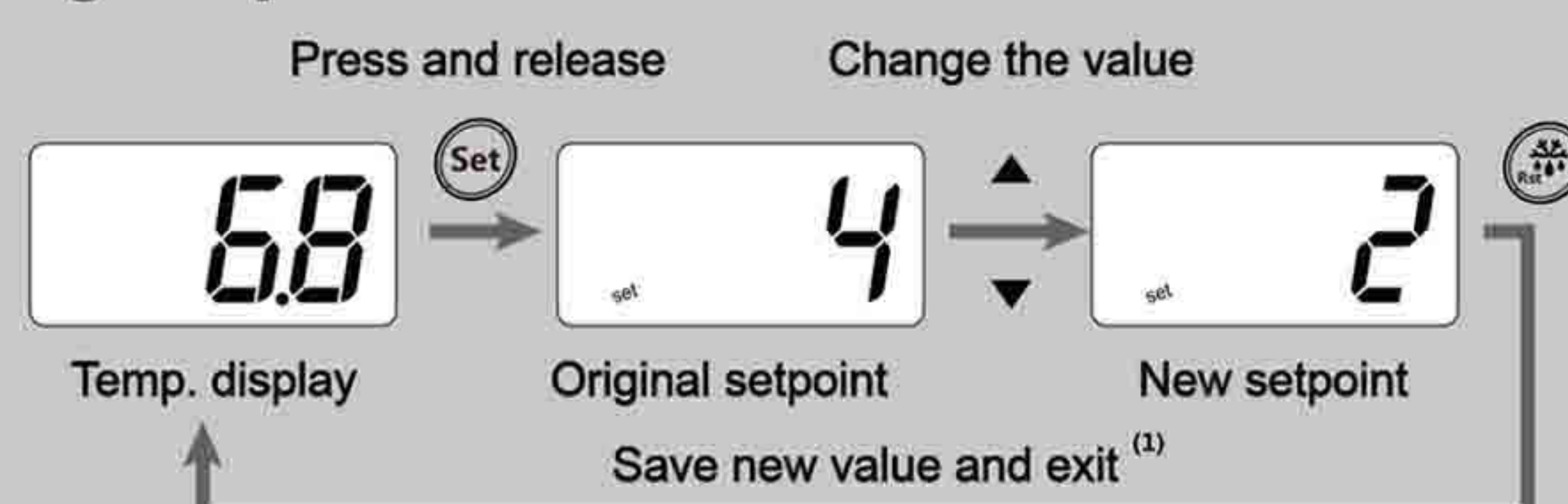

Change other parameters(manager parameters)

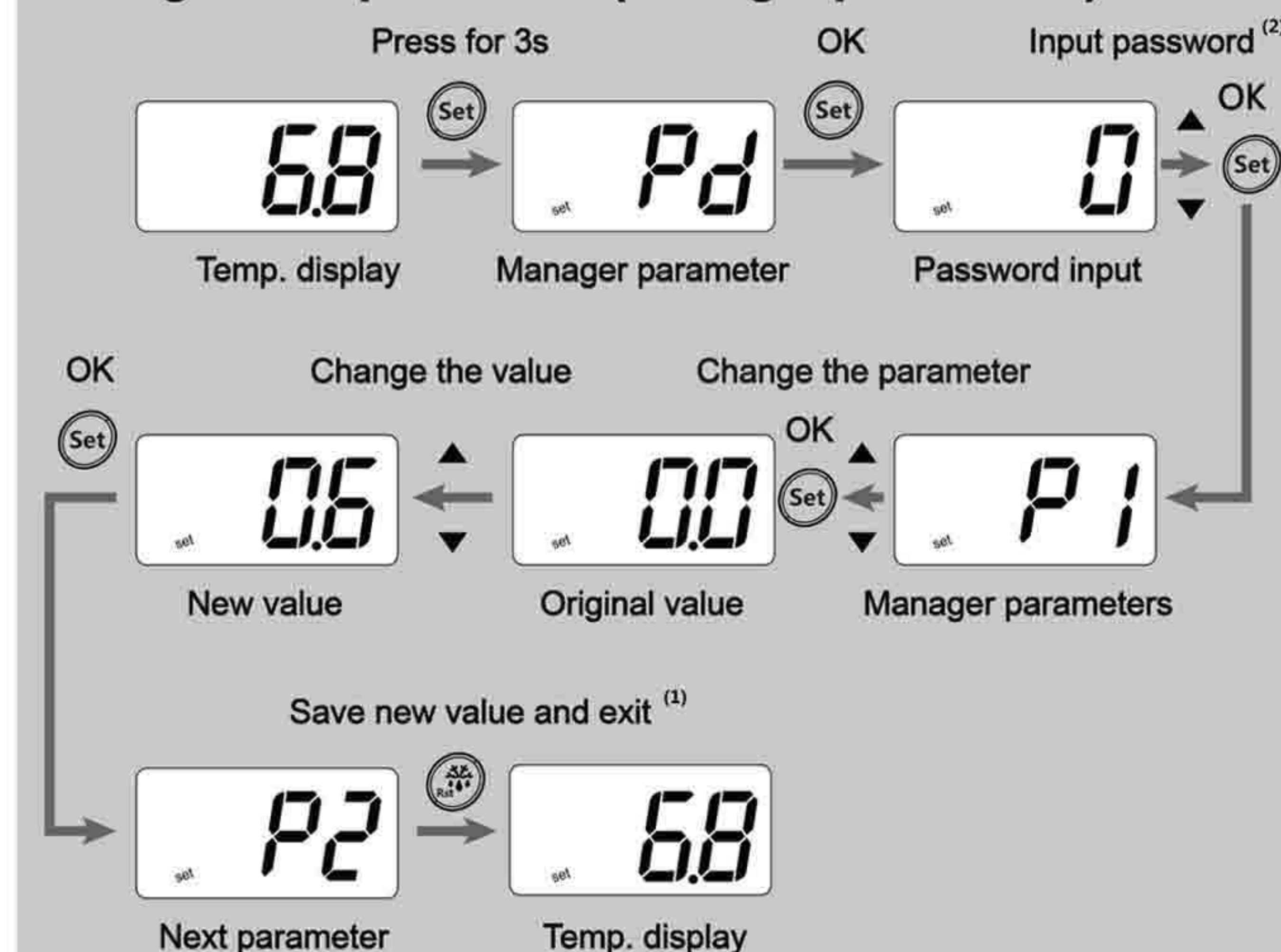

Note(1) : In the process of changing the shutdown temperature or changing other parameters, if there is no key operation for more than 15 seconds, the controller will automatically save the value and exit ;

Note(2) : The default password is 55 ;

4. PARAMETERS

No.	Label	Default	Description	Range
0	SP	4°C	Set point	r1 ~ r2
1	Pd	0	Password input ⁽¹⁾	0 ~ 255
2	P1	0.0°C	First probe calibration ⁽²⁾	-10.0°C(-20°F) ~ 10.0°C(20°F)
3	P2	0.0°C	Second probe calibration ⁽²⁾	-10.0°C(-20°F) ~ 10.0°C(20°F)
4	PP	1	Second probe function	0: disable 1:Evap. 2:Cond.
5	Pr	0	Second relay function ⁽³⁾	0:defrost 1:fan 2:light
6	Pu	1	Temperature unit ⁽⁴⁾	0:°F 1:°C
7	Pt	0	Display delay ⁽⁵⁾	0~90(unit:10s), 0:disable
8	P7	1	Set point unlock ⁽⁶⁾	0:disable 1:enable
9	POF	1	Standby mode function	0:disable 1:enable
10	PAS	55	Password setting	0~255, 0:no password
11	rd	4.0°C	Differential	0.5°C(1°F) ~ 10.0°C(20°F)
12	r1	-2°C	Minimum Set point	-50°C(-58°F) ~ St
13	r2	8°C	Maximum Set point	St ~ 85°C(185°F)
14	c1	0	minimum compressor off time	0 ~ 30 min
15	cF	1	Comp. operating mode with faulty probe	0:always Off 1:ON-OFF as prog. c4/c5
16	c4	10	Comp. Off time with faulty probe	5 ~ 60 min
17	c5	20	Comp. On time with faulty probe	5 ~ 60 min
18	di	2	Interval between def. cycles ⁽⁷⁾	0 ~ 90 h, 0:defrost
19	dt	12°C	Defrost termination temp. ⁽⁸⁾	0 °C(32 °F) ~ 50 °C(122 °F)
20	dP	30	Maximum length for defrost ⁽⁸⁾	1 ~ 90 min
21	F0	0	Fan operating mode	0:continuous mode 1:continuous mode,Off during def. 2:runs with comp.,On during def. 3:runs with comp.,Off during def.
22	A1	-10°C	Minimum temperature alarm	-50°C(-58°F) ~ A6
23	A2	30°C	Maximum temperature alarm	A5 ~ 85°C(185°F)
24	Ad	180	Temperature alarm delay	0 ~ 240 min
25	cdH	58°C	Condenser High temp. alarm	30°C(86°F) ~ 90°C(194°F)
26	cdP	70°C	Condenser High temp. protect	30°C(86°F) ~ 90°C(194°F)
27	cdd	5°C	Cond. High temp. differential	1°C(2°F) ~ 15°C(30°F)

Note (1): The Default password is 55, and the user can cancel or modify the password through the parameter PAS;

Note (2): Display temperature = cabinet temperature probe temperature + first probe calibration P1, the display temperature is also used for compressor ON-OFF control;

Note (3): This parameter is only valid for the product model (EZ12/EZ12D series) that supports the second relay (10A relay in the wiring diagram);

Note (4): If you need to change the temperature unit, all you need to do is change the Pu parameter and save it. The controller automatically converts the corresponding temperature parameter;

Note (5): When the cabinet temperature rises, the cabinet temperature display needs to delay Pt time every time 1°C or 1°F is updated (if Pt=2, the delay time is 20 seconds);

Note (6): If P7=0, it is not allowed to adjust the set point; if POF=0, it is forbidden to enter the standby mode;

Note (7): The defrost time interval refers to the interval between the end of the last defrost and the start of the next defrost;

Note (8): At the beginning of defrosting, if the temperature of the evaporator probe (if second probe and PP=1) ≥ the defrosting termination temperature dt, the defrosting will not be performed this time;

During the defrosting process, if the evaporator probe temperature ≥ defrost termination temperature dt, the defrosting will be terminated ;

If the defrosting process lasts for the longest defrosting time dP, the temperature of the evaporator probe is still smaller than the defrost termination temp. the defrosting is terminated;

If the evaporator probe is not activated (PP=0 or 2) or malfunction (E2), the dt parameter is invalid, and each defrost is executed according to Maximum length for defrost;

Note (9): Parameter modification will not be notified.

5. ALARM SIGNALLING

Code	Description	Alarm activation conditions	Alarm release conditions
E1	Cabinet probe fault	Wrong probe is used or the probe is disconnected or short-circuited	Use the correct type of probe and connect correctly and reliably
E2	Evap. probe fault		
E3	Cond. probe fault		
rH	High temp. alarm	Cabinet probe temp. ≥ A2 last longer than Ad time	Cabinet probe temp. < A2
rL	Low temp. alarm	Cabinet probe temp. ≤ A1 last longer than Ad time	Cabinet probe temp. > A1
cH	Cond. high temp. alarm	Cond. probe temp. ≥ cdH last longer than 30 mins	Cond. probe temp. ≤ cdH-cdd
cP	Cond. high temp. protections	Cond. probe temp. ≥ cdP	Cond. probe temp. ≤ cdP-cdd last longer than 15 mins
dEF	Defrost is progress	/	/
Loc	Set point lock	Attempt to modify the setpoint when P7=0	Disappear automatically
rSt	Parameters reset successfully	/	/

Note (1): If the second probe is not connected, but the parameter PP is set to 1 (evaporator) or 2 (condenser), the E2 fault code (evaporator probe fault) or E3 fault code (condenser probe) will appear. At this time, you only need to set the parameter PP to 0 to solve the fault;

Note (2): When the condenser high temperature alarms, only the fault code cH is displayed, and the output is not affected. The fault code will be automatically cleared after meeting the alarm release conditions;

Note (3): In addition to displaying the fault code cP when the condenser is under high temperature protection, the compressor, defrost heating wire, and fan are forced to shut down; the compressor, defrost heating wire, and fan return to normal control after meeting the fault removal conditions. But the fault code cP cannot be cleared automatically, it can only be cleared by a) powering off and then powering on the controller or b) first entering standby mode and then powering on.

6. TECHNICAL DATA

Material : Front panel: PC
Housing: ABS (UL94-V0)
Waterproof cover: ABS (optional) (UL94-V0)

Dimensions : Front panel 77.5×34.0mm

Installation size : 71×29mm

Protection : Frontal IP64

Power supply : 220VAC±10% , 50/60Hz(EZ1xx2 series)
or 110VAC±10% , 50/60Hz(EZ1xx1 series)
or 12VAC/VDC±5%(EZ1xx12 series)

Power consumption : 3.0VA max

Display mode : three-digit digital tube (red/white/blue optional)

Resolution : 0.1°C

measurement range : -50°C ~ 90°C

measurement accuracy : -40°C ~ 50°C ±1°C, the rest ±2°C

Input signal : 2 NTC temperature probes

Relay : Compressor relay: 30A/240VAC normally open output, can directly drive single-phase 1.5HP compressor
The second relay: 10A/240VAC normally open output (can be configured by Pr parameter used as a defrost heater, fan or light relay)

Operating temperature : 0°C ~ 55°C

Storage temperature : -25°C ~ 75°C

Relative humidity : 20% ~ 85%(no condensation)

RF Wireless Remote Advanced

RGB LED Controller

INSTRUCTIONS

- 22 Dynamic Modes
- 20 Static Colors
- Very Smooth Effects
- Speed Adjustable
- Brightness Adjustable
- Card Type RF Remote
- Ultra Slim Design
- Dynamic Demo Mode
- Easy Remote Pairing
- Direct Color Select

Functions

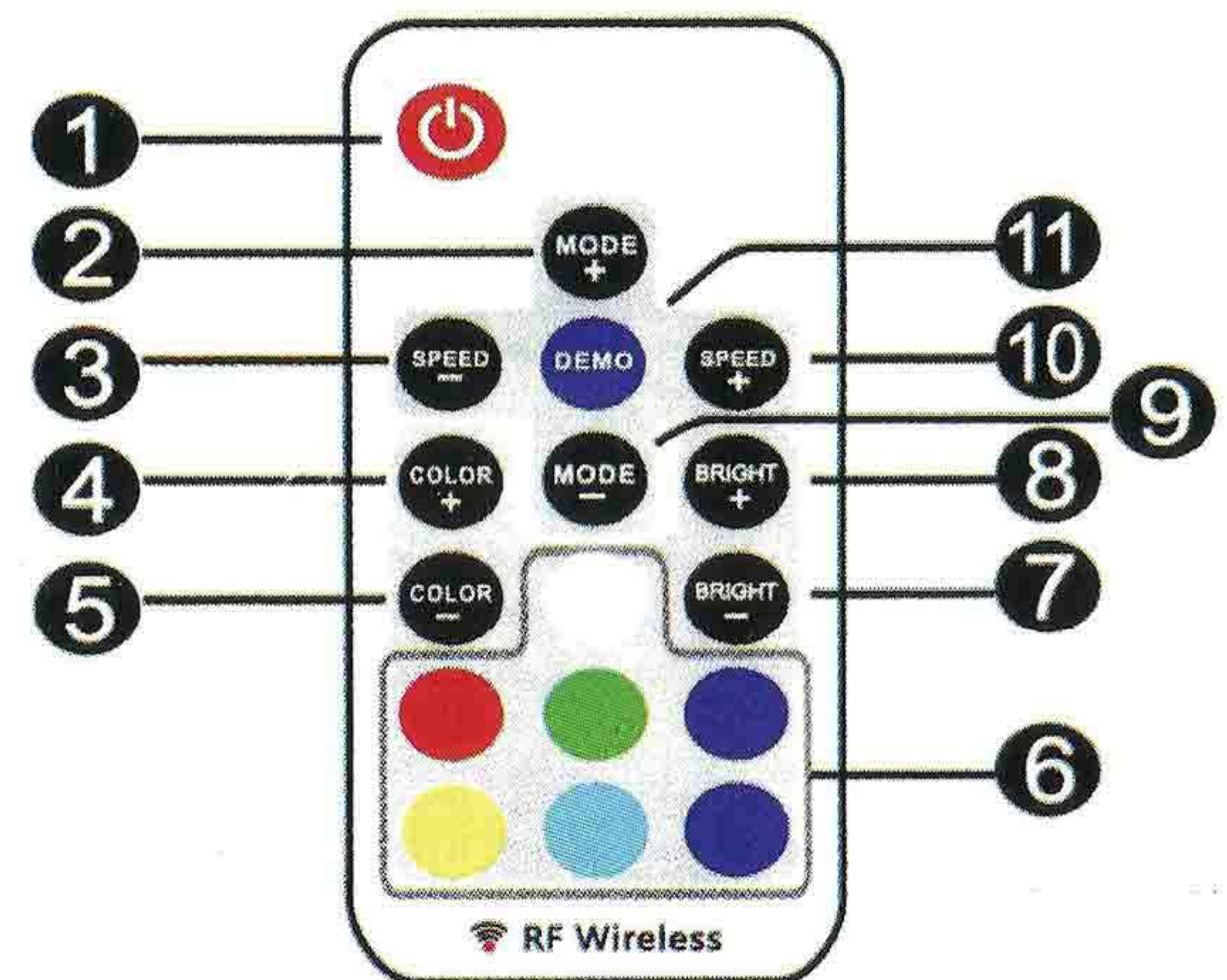

1 Turn on/standby

- Press this key to turn on unit or switch to standby mode. At power on, unit will automatically turn on and restore to previous status.

2/9 Dynamic Mode Adjust

- Switch to dynamic mode from static color, or switch between dynamic modes.

3/10 Dynamic Speed Adjust

- Adjust dynamic playing speed. Press SPEED+ to increase speed and press SPEED- to decrease. Unit will switch to dynamic mode if press this key at static color mode.

4/5 Static Color Adjust

- Switch to static color mode from dynamic mode, or switch between static colors.

6 Direct Color select

- Shortcut key to static colors. When press the specific color key, LED will play the same static color. The direct colors are included in 'CoLoR+' and "CoLoR-" operation.

7/8 Brightness Adjust

- Adjust static color brightness. Press BRIGHT+ to increase brightness and press BRIGHT- to decrease. Unit will switch to static color mode if press this key at dynamic mode.

11 Demo Mode

- Press this key will switch to Demo mode. At demo mode, it plays 17 dynamic modes in loop, each mode repeat 3 times.

INSTALLING

This unit accepts DC 5V to 24V power supply. The DC jack's inner pole (or red cable) is positive and sleeve (or black cable) is negative, Also please make sure the power supply voltage is same as the LED load.

This unit support common anode connection LED products. The mark 's' indicates the common connection node.